

COMPETITION SCHEDULE

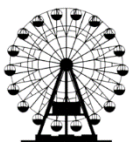

**CAIRNS
SHOW**



**16TH - 18TH
JULY 2025**

**SECTION 27
CRAFT &
NEEDLEWORK**

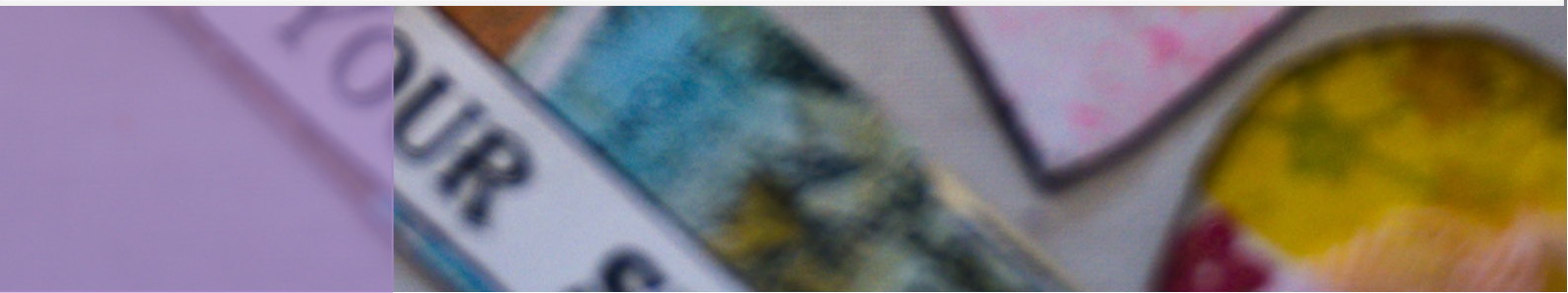

CAIRNS SHOW COMMITTEE 2025

Honourary Patron:	Mr. Francis (Ley) James
President:	Mr. Ian Allen
Senior Executive Vice President:	Mr. Desmond Tong
Treasurer:	Ms. Narelle Phipps
Assistant Treasurers:	Mr. Christopher Van Dorssen Mrs. Linda Halliwell
Executive Vice President:	Mr. Bevan Clayton Mr. Glen Hunter Mr. Francis (Ley) James Mr. Nathan Lee Long
Management Committee:	Mrs. Carolyn Allen Ms. Margrit Allen Mr. Kent Hams Mr. Leslie Plath Mr. Daniel Sale Mr. Michael Tonion Mr. Louis Underwood
General Committee:	Ms. Judy Alyce Mrs. Janice Anderson Mr. Raven Cook Mr. Michael Fischer Mr. David Green Mr. Dean Hault Ms. Amanda Hunter Ms. Glenda McAuliffe Mr. Warren March Mr. Malcom O'Hara Mr. Robert O'Malley Mr. Michael Pattini Mr. William (Bill) Smith Mrs. Christine Stoddart Mr. Robert Stoddart

CAIRNS SHOW STAFF 2025

Manager/Secretary:	Mr. Ian Moller-Nielsen
Entertainment/Competitions Coordinator:	Miss. Amy Jones / Miss. Heather Rowlands
Venues/Sites Coordinator:	Ms. Emily Barker
Finance Officer:	Mrs. Naomi Stewart
Receptionist:	Miss. Heather Rowlands / Miss. Jolena Takai Mr. Anthony Miano
Groundsmen:	Mr. Adam Pritchard Mr. Jeremy Pyke

WELCOME FROM THE PRESIDENT

Welcome to the largest regional agricultural show, where we proudly showcase the very best of Far North Queensland's agricultural, pastoral, mining, and cultural industries. We are passionate about bringing the country to the city, celebrating our region's rich heritage and vibrant community spirit.

Each year, this event brings together a diverse range of agricultural, cultural, and artistic experiences designed for children, young people, and families from local, regional, and remote communities. These activities are not only educational and entertaining but also create wonderful opportunities for families to connect and make lasting memories.

The Cairns Show is also home to a variety of exciting competitions, where exhibitors and competitors from across the region put their skills, craftsmanship, and dedication on display. From livestock judging, equestrian events, and woodchopping contests to arts, photography, cooking, and horticulture exhibits, these competitions highlight the incredible talent and hard work within our community. Whether you're a seasoned competitor or a first-time entrant, the competitive spirit of the Show is an integral part of what makes this event so special.

The Cairns Show and its grounds stand as a testament to the dedication of our region, proudly hosting the largest Showmen's Guild entertainment outside of Brisbane's EKKA.

I would like to extend my sincere gratitude to our hardworking staff, Committee, and volunteers, whose tireless efforts behind the scenes make this event possible. Your commitment and dedication do not go unnoticed.

To our visitors—thank you for being part of this celebration. Your support and enthusiasm are what make the Cairns Show such a special event year after year.

A heartfelt thank you also goes to our generous sponsors. Your contributions are invaluable in ensuring we continue to deliver the high-quality show that our community has come to know and love.

With an exciting lineup of attractions, entertainment, competitions, and experiences, there's so much to see and do—you'll be hard-pressed to fit it all into just one day!

So come along, immerse yourself in the fun, and enjoy everything your local show has to offer.



Mr. Ian Allen

President, Cairns Show Association

Cairns Agricultural, Pastoral, and Mining Association





ESSENTIAL SHOW INFORMATION

Cairns Show

Wednesday 16th, Thursday 17th, and Friday 18th July 2025

Gate Opening Times:

9am to 9pm daily - *some attractions closing times may vary.*

Cairns Show Map:

The Map is available at all Gate Entrances as well as in the Cairns Show Guide, online via the Cairns Show Website, Facebook, and Instagram pages.

Gate Entrances:

1. Corner of Severin St and Mulgrave Rd (Main Gates).
2. Quigley Street.
3. Mulgrave Rd, in front of the Fred Moule Exhibition Centre.
4. Scott Street.

Taxi Ranks:

1. Mulgrave Rd, in front of the Honey Providore Horticulture Pavilion.
2. Scott St, near St Augustine's College.
3. Corner of Mulgrave Rd and Severin St.

Bus Stops:

Sunbus Pickup and Drop Offs Points:

1. To the City – Mulgrave Road opposite the Show Ground Main Entrance
2. From the City – Mulgrave Road in front of the Cairns Youth Centre
3. Disabled Set down is the Corner of Mulgrave Road and Severin Street.

Accessible Parking:

Parking Bay Locations:

1. 5 bays in Severin Street, near Mulgrave Road
2. 5 bays in Severin St, outside St Augustine's College Swimming Pool.

Toilets:

Please refer to the Cairns Show Map for Toilet locations.

ATMS:

1. Immediately inside the Main Gate Entrance in front of the Cairns Show Office.
2. Outside the Fred Moule Exhibition Centre.
3. Immediately inside the Scott St Entrance next to the Sideshow Alley Rides.

First Aid:

1. Medical Outpost, near the Main Gate Entrance.
2. Clive Gordon Main Arena (Centre Ring).
3. Opposite Animal Nursery.

Smoking:

The Show is a smoke-free environment. Smoking is only permitted in signed, designated areas. Please refer to the Cairns Show Map for Smoking areas.

Cloakroom:

Next to the Show Office, Volunteers from the FNQ Hospital Foundation will look after your items while you enjoy the Show. There is FREE sunscreen available.

Wheelchair/Trolley Hire:

Unfortunately, we do not have Wheelchair or Trolley Hire at the Cairns Show. Please come prepared and refer to the Cairns Show Map for Rest and First Aid locations.

Dogs & Animals:

Dogs & Animals are not permitted at the Cairns Show! If you bring an animal with you will be denied entry. Exceptions to this: Service & Guide Dogs, or Animals approved for medical purposes (certificate/identification of approval will need to be shown to gate staff/security). Competitors competing in the Cairns Show Association Dog Show Championship will be able to enter the Dog Show/Campgrounds areas only – please enter via Quigley St.

GATE ADMISSION CHARGES

TICKETING INFORMATION

1. Purchasing Tickets Online is strongly encouraged. To purchase Tickets Online, visit the Cairns Show website at www.cairnsshow.com.au.
2. Presold (discounted) Tickets will be available at Earlville Shopping Town and Online. To purchase Presold Tickets please refer to the information below.
3. Tickets can be purchased At the Gates during the Show. Cashless payment is preferred, however, limited ATMS will be available around the grounds. Please refer to the Cairns Show Map for ATM locations.
4. Please note: a Transaction Fee Per Order will be payable to the Ticketing Merchant for all Ticket Orders online and in person.
5. By purchasing a Ticket, you agree to the Terms & Conditions outlined on our website.

PRESOLD TICKETS

You can buy discounted Presold Tickets either online at www.cairnsshow.com.au or at Earlville Shopping Town from Friday 5th to Monday 14th July, between 9am and 5pm. On Tuesday 15th July, tickets will be available at the Main Gates of the Cairns Showgrounds from 9am to 5pm, but only online purchases will be available after 5pm.

Presold Ticket Types:

Valid for One Day – Any Day of the Cairns Show.

- **Adult (18 Years and Over):** \$27
- **Concession/Pension:** \$23*
- For individuals 14 Years and Over with a Valid Student ID or Pensioners Card.
- *Please note: a discounted Concession/Pension Voucher will be published in the local newspaper, offering Concession/Pensioners One Day – Any Day Entry at \$21. Refer to the Cairns Show website for more information.
- **Child (5 Years to Under 14 Years):** \$15
- **Child (Under 5):** Free
- **Family Pass (2 Adults & 2 Children):** \$70
- Children must be aged 5 Years to Under 14 Years.
- Family members will receive individual tickets, allowing them to enter at different times during the same day.

TICKETS AT THE GATE

Starting from 12am Wednesday 16th July, ticket prices will revert to the standard gate prices as listed below.

Ticket at the Gate Types:

Valid for One Day – Any Day of the Cairns Show.

- **Adult (18 Years and Over):** \$30
- **Concession/Pension:** \$24
- For individuals 14 Years and Over with a Valid Student ID or Pensioners Card.
- **Child (5 Years to Under 14 Years):** \$16
- **Child (Under 5):** Free
- **Family Pass (2 Adults & 2 Children):** \$75
- Children must be aged 5 Years to Under 14 Years.
- Family members will receive individual tickets, allowing them to enter at different times during the same day.

BONUS DOLLARS

1. Bonus Dollars are NOT available for purchase online.
2. One sheet of Bonus Dollars is \$25 for a \$30 value.
3. Bonus Dollars may only be used in Sideshow Alley at the Cairns Show, and can be redeemed on the following: Rides, Food and Games. NOT redeemable on Showbags. Bonus Dollars are not transferable and cannot be replaced if lost, stolen or misplaced. Unused tickets are non-refundable.

CAIRNS SHOW ASSOCIATION MEMBERSHIP

MEMBERSHIP INFORMATION

Become a Member of the Cairns Agricultural, Pastoral and Mining Association and receive a range of benefits at the Cairns Show, Cairns Show Wine Awards, the Cairns Show Auto Spectacular, and throughout the year.

1. To Apply for Membership and more information on Benefits, visit our website.
2. ALL Membership Types can be used for THREE DAY entry of the Cairns Show.
3. 2025 Membership Applications/Renewals open January 2025, and close Friday 11th July 2025.
1. Membership year ending 31st December 2025. The Cairns Show Association has the right to refuse your application. Limited Applications are available and accepted.
2. By purchasing a Cairns Show Ticket, Membership, and/or Bonus Dollars, the holder agrees to the CAPMA Copyright, Privacy Policy, and Disclaimer. Please refer to our website for more information.

MEMBERSHIP TYPES

Annual Member: \$95 or pay \$950 for a Permanent 10-Year Membership.

CAPMA members 18 years and over receive the following benefits:

1. One (1) Member's Shield gaining unrestricted, three-day entry to the Cairns Show (single person entry).
2. One (1) Member's Guest Shield gaining unrestricted, three-day entry to the Cairns Show (non-transferable, single person entry).
3. Access to the De Jarlais Member's Pavilion during the Cairns Show. Buffet and bar not included in Membership (payable to vendor on the day).
4. Access to Member's Exclusive Deals during the Cairns Show.

ShowTime Member: \$55

As a ShowTime promotion only, ShowTime Members receive the following benefits:

1. One (1) Member's Shield gaining unrestricted, three-day entry to the Cairns Show (single person entry).
2. Access to the De Jarlais Member's Pavilion during the Cairns Show. Buffet and bar not included in Membership (payable to vendor on the day).
3. Access to Member's Exclusive Deals during the Cairns Show.

Concession Member: \$17

CAPMA Members between 14 years to under 18 years receive the following benefits:

1. One (1) Member's Shield gaining unrestricted, three-day entry to the Cairns Show (single person entry).
1. Access to the De Jarlais Member's Pavilion during the Cairns Show. Buffet and bar not included in Membership (payable to vendor on the day). Those under the age of 18 years must be always accompanied by an Adult!

Those 18 years or over receive the above and:

1. MUST hold a and present Valid Concessional Student Identification card.
2. Access to Member's Exclusive Deals during the Cairns Show.

Child Member: \$12

CAPMA Members 5 to under 14 years receive the following benefits:

1. One (1) Member's Shield gaining unrestricted, three-day entry to the Cairns Show (single person entry).
2. Access to the De Jarlais Member's Pavilion during the Cairns Show. Buffet and bar not included in Membership (payable to vendor on the day). Those under the age of 18 years must be always accompanied by an Adult.

GENERAL CONDITIONS - COMPETITIONS

ENTRY & COMPETITIONS

This Show operates under the regulations set forth by the Queensland Chamber of Agricultural Societies, the constitution, and rules of this Society, as well as any regulations specified within the individual sections of this Show's Schedule. In the event of any conflict between these rules and regulations, those outlined in the Schedule of this Society shall take precedence. For detailed information on the rules and regulations of the Queensland Chamber of Agricultural Societies, please visit www.queenslandshows.com.au.

By participating in any class outlined in this Schedule, all individuals agree to indemnify the CAIRNS AGRICULTURAL PASTORAL AND MINING ASSOCIATION against liability for any accidents, damages, losses, or illnesses to any Exhibit, Exhibitor, or Competitor. Additionally, participants acknowledge that all Competitions are under the complete control of the CAIRNS AGRICULTURAL PASTORAL AND MINING ASSOCIATION, whose decisions in all matters are final.

THE CAIRNS AGRICULTURAL PASTORAL AND MINING ASSOCIATION

1. No Competition Entries or Membership Applications will be taken over the phone.
2. A Chief Steward will be assigned to each Section to represent it in all matters. Failure to adhere to lawful directions from appointed Stewards, Committee, or Staff, or engaging in verbal or physical abuse, will result in Disciplinary Action, which may include exclusion from further Competitions and/or the Cairns Showgrounds.
3. Judges will be appointed, and their decisions will be final. No verbal or written communication will be entertained or considered.
4. **The organizers reserve the right to make any necessary decisions, inclusions, or changes to this Schedule, including Conditions of Entry and Special Regulations, without further notice.**
5. By entering this Competition, exhibitors acknowledge their compliance with these Conditions.
6. Judges at The Cairns Show are prohibited from having any prior or during judging information beyond what is provided by the Cairns Agricultural Pastoral and Mining Association. Vice Presidents are not permitted to compete in sections under their control.

ANIMAL AND BIRD EXHIBITORS

1. All animal and bird exhibitors are required to sign an Exhibit Health Declaration upon delivering their entry and must adhere to the health requirements outlined in this document. Exhibit Health Declarations can be obtained from the Show Office or the website www.cairnsshow.com.au.
2. Owners of animals are responsible for any veterinary fees incurred. The Cairns Show will not assume responsibility for any veterinarian expenses.
3. Please take note of the following conditions for entry into the grounds:
 - a. Glass items are prohibited on the grounds.
 - b. All electrical leads must be appropriately tagged in accordance with relevant industrial regulations.
 - c. Dogs must be kept on a leash at all times.

PRIZE MONEY & GST

The Prize Money listed in the Schedule does not include GST. GST will be added to the Prize Money for exhibitors who are registered for GST purposes. The Association will issue a "Recipient Created Tax Invoice" to exhibitors who are registered for GST purposes.

PRIVACY STATEMENT

The Cairns Show Association uses the information you provide in Membership or entry applications to offer member services and to organize and conduct competitions at the Cairns Show. By applying for Membership or entering our competitions, you consent to provide details such as your name, address, and exhibit details. Competition details may be shared with the media and included in publications. Your information will not be disclosed for any other purpose without your consent, except as required by law.

SECTION 27 CRAFT & NEEDLEWORK

OFFICIALS

Chief Steward: Ms. Carol Coates

Steward: Mrs. Jan Anderson, MS. Mary Mattson, Mrs. Chris Osborne, and Mrs. Sandra Bawden.

KEY INFORMATION

Entry Fee: FREE

Prize: 1st - \$8 + Card, 2nd - \$4 + Card, 3rd - Card, Highly Commended Card - *unless otherwise stated*

Entries Close: 4pm Friday 20th June. Entries on the day of Delivery may be accepted.

Delivery of Exhibits: 9am-4pm Thursday 10th July and Friday 11th July - WIN News Arts & Crafts Pavilion (underneath De Jarlais Function Centre). Lapidary must be taken to the Fred Moule Exhibition Centre (refer to Sub Section for notes).

Judging: 9am Saturday 12th July.

Collection of Exhibits: 10am-2pm Saturday 19th July - Main Arena (Centre Ring) side of Arts & Crafts Hall.

SPONSORS

The Cairns Show Association wishes to record its sincere appreciation to the following Sponsors who have contributed to this area.

Channel 9 WIN News, and Showbag Warehouse.

HOW TO ENTER

1. Complete an Entry online or in person at the Cairns Show Office, or post via PO Box 811 Bungalow, QLD 4870.
2. Entries will not be accepted over the phone. Entries may be accepted on the day of Delivery.
3. Entries must be delivered to the designated part of the Showgrounds by the due date time and date shown.

AFTER THE SHOW

1. Exhibits NOT collected by Friday 29th August 2025 will become Property of the Cairns Show Association.
2. Prize Money can be collected between 9am and 4pm Monday to Friday 4th August to 29th August from the Show Office if your total prize money is less than \$50.
3. Proof of identity is required to collect Prize Money. If you are collecting prize money on behalf of someone else, a letter of authorisation from that person will be required.
4. All Prize Money less than \$50 not collected by 29th August, 4pm will be returned to the Cairns Show Association Funds.
5. Prize money of \$50 and over will be deposited to the entrant's nominated bank account after 29th August. Please ensure you have provided your bank details to the Cairns Show Office. If you have not, a staff member will contact you via email.
6. Results will be available from the [Cairns Show website](#) AFTER the conclusion of the Show.

SPECIAL REGULATIONS

PLEASE READ SPECIAL REGULATIONS FOR THE CLASS YOU ARE ENTERING THOROUGHLY

1. Refer General Conditions of Entry and Competition in the front of this Schedule.
2. All exhibits must be the original and unaided work of the exhibitor. Factory made articles are not allowed in this Section.
3. No exhibit can be entered into more than one class.
4. All exhibits in Junior Classes must be nominated under their name, signed by an adult and include date of birth on entry form.
5. All exhibits must have been executed/completed within the last twelve (12) months prior to the 2025 Cairns Show.
6. To assist the Stewards in arranging and dispatching exhibits after the Show, a sealed envelope containing name and address of owner must be securely attached to the back of each exhibit.
7. Please attach Class Card to the back, bottom right-hand corner of the exhibit, the class card must be visible.
8. Name and address or contact number must also be on the back of the Class Card.
9. All exhibits forwarded by mail must include return postage. The Cairns Show Association takes absolutely no responsibility for items forwarded by mail.
10. No person other than Judges, Chief Steward and Stewards to be present while Judging is taking place. Arts & Crafts Pavilion will be locked during Judging.
11. The Judge reserves the right to alter the Class of an exhibit.
12. Out of town exhibitors may collect exhibits AFTER the fireworks for 30 minutes on Friday Night 18th July 2025. Prior arrangements must be made with the Chief Steward.
13. In the event of an exhibit in any one class not being worthy of a prize, no prize money will be awarded.
14. Please deliver items between 9am - 4pm on Thursday 10th and Friday 11th July 2025.
15. Exhibits may be collected from 10am to 2pm Saturday 19th July 2025 from The Arts and Crafts Hall - Ring Side (underneath the De Jarlais Function Centre at the Showgrounds).
16. No responsibility will be taken for exhibits left in the Arts & Crafts Hall after this time.
17. No free passes available to exhibitors.
18. All exhibits in the Craft Classes should be suitably framed and wired ready for hanging otherwise they will not be hung.
19. All exhibits for sale must be clearly marked with price. Exhibits not for sale must be marked "NFS".
20. Commission of 20% will apply to all works sold and must be included in the sale price. Please liaise with Chief Steward.
21. Sold exhibits must not be removed until Saturday 19th July 2025.
22. Please ensure you are aware of your class number. This is the number on the far-left hand side of the class description in Schedule.
23. Translation card (if necessary) attached to item on the right-hand corner at the front.

CRAFT

OPEN CRAFT

Class 27001 Thrift Article

Made from scrap material - any medium

Class 27002 Any Upcycled Article

Any medium - Paper, Metal, Wood, Fabric. Description to be included.

Class 27003 Woodburning

Class 27004 Novelty Article

Class 27005 2 Coat Hangers

Any medium - 2 distinctive patterns.

Class 27006 Toy

Any medium - not knitted or crocheted.

Class 27007 Macrame

Class 27008 Beadwork - Jewellery

Class 27009 Beadwork - Any Other Article

Class 27010 Glass

Example: beads, slumped glass, etc.

Class 27011 Mosaic - 2 Dimensional

Class 27012 Mosaic - 3 Dimensional

Class 27013 Dressed Doll

Class 27014 Scrapbooking - Category 'Christmas'

Open Class - One page, in plastic sleeve.

Class 27015 Scrapbooking - Category 'Celebration of Anything'

Open Class - One page in plastic sleeve.

Class 27016 Scrapbooking - Category 'Heritage'

Open Class - One page in Plastic Sleeve

Class 27017 Paper Crafting Card

For any Occasion and Technique

Class 27018 Paper Crafting Technique

Handmade Books, Altered Books and Paper Tole

Class 27019 Christmas Decoration - Any Article

Class 27020 Millinery

Any medium, any style.

Class 27021 Resin Work

Class 27022 Any Other Article Not Mentioned

COMBINATION CRAFT

Class 27023 Any Article

Open Class - Wood metal, wire, mixed media, crochet/knitting, sewing/dying - Be creative

Class 27024 Group Projects

5 people or more

CRAFT – CONTINUED

HAND DRAWN ART

Created Using Repetitive Patterns (Tangles)

SPECIAL REGULATIONS

1. Min Size: Greeting Card
2. Max Size: A4
3. No signatures on front of artwork

Class 27025 Abstract Repetitive Patterns (Tangles)

Viewed from any orientation. Black, white with grey shading palette only.

Class 27026 Traditional Art or Structured

Designed together with Repetitive Patterns (Tangles). Viewed from a specific oriental. Any colour palette.

CHAMPION OPEN CRAFT OF SHOW - \$20

Open to Classes 27001 - 27026

Prize: \$20 + Sash

FOLK ART

All Folk Art exhibits must comply with the Conditions of Entry.

Class 27027 Folk Art – Junior

For children Under 15 Years. MUST have been completed in a classroom situation and must be the unaided work of the exhibitor.

Class 27028 Folk Art – Beginners

Less than 2 Years experience

Class 27029 Folk Art – Intermediate

Over 2 Years experience

Class 27030 Folk Art – Open Traditional

Baroque, Bauernmaleri Hinderloopen, Intarsia, Naïve, Rosemailing, Russian Floral.

Class 27031 Folk Art – Open Decorative

Floral and other themes, boats, fairies, lace, teddies, etc.

CHAMPION FOLK ART OF SHOW - \$20

Open to Classes 27028 - 27032

Prize: \$20 + Sash

JUNIOR CRAFT - 12 YEARS AND UNDER

Prize: 1st - \$5, 2nd - \$3, 3rd - \$2, Highly Commended Card.

Class 27032 Beadwork

Any Article

Class 27033 Novelty - Made from Paper Plate

Class 27034 Christmas Decoration

Hanging Christmas Tree Decoration or Christmas Table Decoration

Class 27035 French Knitting

Any Article

Class 27036 Toy

Any Article

Class 27037 Paddle Pop Sticks

Any Article

CRAFT – CONTINUED

Class 27038 Paper Mache

Any Article

Class 27039 Scrapbooking

Junior Class - Any Category, One Page, in Plastic Sleeve.

Class 27040 Loom Craft

Class 27041 Any Other Article Not Mentioned

Class 27042 Paper Crafting Card

Card for any Occasion and Technique.

Class 27043 Any Machine Sewn Article or Clothing

Class 27044 Two Coat Hangers

Any Medium

CHAMPION JUNIOR CRAFT 12 YEARS AND UNDER OF SHOW - \$20

Prize: \$20 + Sash

JUNIOR CRAFT - 13 YEARS TO UNDER 18 YEARS

Prize: 1st - \$5, 2nd - \$3, 3rd - \$2, Highly Commended Card.

Class 27045 Beadwork

Any Article

Class 27046 Novelty Made from Paper Plate

Class 27047 Christmas Decoration

Hanging Christmas Tree Decoration or Christmas Table Decoration.

Class 27048 French Knitting

Any Article

Class 27049 Toy

Any Article

Class 27050 Paddle Pop Sticks

Any Article

Class 27051 Paper Mache

Any Article

Class 27052 Scrapbooking

Junior Class - Any Category, One Page, in plastic sleeve.

Class 27053 Loom Craft

Class 27054 Any Other Article Not Mentioned

Class 27055 Paper Crafting Card

For any Occasion and Technique

Class 27056 Any Machine Sewn Article or Clothing

Class 27057 Two Coat Hangers

Any Medium

CHAMPION JUNIOR CRAFT 13 YEARS TO UNDER 18 YEARS OF SHOW - \$20

Prize: \$20 + Sash

NEEDLEWORK

KEY INFORMATION

Entry Fee: FREE

Prize: 1st - \$8 + Card, 2nd - \$4 + Card, 3rd - Card, Highly Commended Card - *unless otherwise stated*

SPECIAL REGULATIONS

1. Exhibits must not be washed but should be well pressed. Cleanliness is essential to hand work.
2. All exhibits must have been executed/completed within the last twelve (12) months prior to the 2025 Cairns Show.

OPEN CROCHET

Class 27058 Infant's Bonnet or Booties

Class 27059 Baby's Outfit

Not less than 3 pieces (a pair of Bootees is classed as 1 piece).

Class 27060 Doyley

Up to 21 cm

Class 27061 Table Centre

Over 21cm

Class 27062 Runner or Tray Cloth

Class 27063 Handkerchief

Class 27064 Lady's Stole or Shawl

Any Medium

Class 27065 Tea Cosy

Any Medium

Class 27066 Cushion

Any Medium

Class 27067 Toy

Any Medium

Class 27068 Bedspread or Knee Rug

Any Medium

Class 27069 Fridge Towel

Class 27070 Any Other Article Not Specified

CHAMPION CROCHET OF SHOW - \$20

Prize: \$20 + Sash

OPEN HAND KNITTING

Class 27071 Infant's Bonnet or Booties

Class 27072 Baby's Outfit

Not Less Than 4 Pieces (a pair of booties is classed as 1 piece).

Class 27073 Adults Pullover, Vest, Cardigan or Garment

Class 27074 Toy

Class 27075 Tea Cosy

Class 27076 Any Other Knitted Article Not Specified

CHAMPION OPEN HAND KNITTING OF SHOW - \$20

Prize: \$20 + Sash

NEEDLEWORK – CONTINUED

MACHINE KNITTING

Class 27077 Machine Knitting Novice

Class 27078 Machine Knitting Open

CHAMPION MACHINE KNITTING NOVICE

Less than twelve months experience

Prize: Sash

CHAMPION MACHINE KNITTING OPEN

Prize: Sash

OPEN HAND EMBROIDERY

Class 27079 Smocked

Any Article. Smocking - 90% Judging 10% Finishing of Article

Class 27080 Applique Work

Class 27081 Table Centre

Class 27082 Cross Stitch Picture Framed

Class 27083 Cross Stitch and Embellishments

Class 27084 Cross Stitch - Any Other Article Not Mentioned

Class 27085 Needlework Picture Including Tapestry

Must be Framed

Class 27086 Tapestry Longstitch Picture

Must be Framed

Class 27087 Hardanger

Any Article

Class 27088 Runner or Tray Cloth

Class 27089 Doyleys

3 Distinctive Patterns

Class 27090 Hand Embroidery Traditional

Class 27091 Hand Embroidery Contemporary

Class 27092 Fabric Hand Stitched Book

Journal may include some free Machine Embroidery. Any Article.

Class 27093 Pin Cushion

Any Medium

CHAMPION OPEN HAND EMBROIDERY OF SHOW - \$20

Prize: \$20 + Sash

BOBBIN LACE

Entry Fee: FREE

Prize Money: 1st - \$50.00, 2nd - \$25.00, 3rd - \$10.00

Class 27094 Bobbin Lace

Type of lace and designers name (or own design) to accompany exhibit.

CHAMPION BOBBIN LACE OF SHOW

Prize: Sash

NEEDLEWORK – CONTINUED

OPEN MACHINE SEWING

Any item professionally quilted must be entered into the relevant section. Example: Patchwork, Applique etc. not into quilting.

Class 27095 Embroidery

Any Medium

Class 27096 Applique Work

Class 27097 Quilting

Any Article

Class 27098 Art Quilt

Class 27099 Child's Garment

Class 27100 Evening Wear

Class 27101 Garment

Class 27102 Decorated Hand Towel and Washer Set

Class 27103 Apron

Class 27104 Patchwork

Class 27105 Bag

Any Medium

Class 27106 Cushion

Any Medium

Class 27107 Machine Sewing

Minimum of 3 Machine Sewing techniques - Any Article.

For example: Patchwork, Quilting, Applique or Machine embroidery. Please provide description of how item was made and what techniques were used. Can include dying and hand embroidery but must have a minimum of 3 Machine Sewing techniques.

Class 27108 Any Other Machine-Made Article Not Specified

Example: printed panel with minimum outline quilting

CHAMPION MACHINE SEWING OF SHOW - \$20

Prize: \$20 + Sash

70 YEARS AND OVER

Class 27109 Crochet

Any Article

Class 27110 Knitting

Any Article

Class 27111 Embroidery Work

Any Article

Class 27112 Novelty

Any Article, including Fabric Books/Journals.

Class 27113 Any Other Article Not Mentioned

Class 27114 Embroidery Work

Free Motion Embroidery Work

CHAMPION 70 YEARS AND OVER

Prize: Sash

NEEDLEWORK – CONTINUED

80 YEARS AND OVER

Class 27115 Any Article

CHAMPION 80 YEARS AND OVER - \$25

Prize: \$25 + Sash – Sponsored by Vjay's Sewing Services



JUNIOR - 12 YEARS OF AGE AND UNDER

State Age on Entry Form.

Prize: 1st - \$5 + Sash, 2nd - \$3, 3rd - \$2, Highly Commended Card

Class 27116 Crochet

Any Article

Class 27117 Knitting

Any Article

Class 27118 Embroidery

Any Article

Class 27119 Novelty Garment

Machine Sewing

Class 27120 Patchwork Bag

Class 27121 Cushion

Machine Sewing

Class 27122 Toy

Any Medium

Class 27123 Dressed Doll

Class 27124 Two Coat Hangers

Any Medium

Class 27125 Pin Cushion

Any Medium

Class 27126 Any Article Not Specified

JUNIOR - 13 YEARS TO UNDER 18 YEARS OF AGE

State Age on Entry Form

Prize: 1st - \$5 + Sash, 2nd - \$3, 3rd - \$2, Highly Commended Card

Class 27127 Crochet

Any Article

Class 27128 Knitting

Any Article

Class 27129 Embroidery Work

Any Article

Class 27130 Garment

Machine Sewing

Class 27131 Nightwear

Machine Sewing

Class 27132 Tea Cosy

Any Medium

Class 27133 Table Centre

Any Medium

Class 27134 Toy

Any Medium

NEEDLEWORK – CONTINUED

Class 27135 Two Coat Hangers

Any Medium

Class 27136 Any Article Not Specified

Class 27137 Pin Cushion

Any Medium

CHAMPION JUNIOR OF SHOW - \$20

Prize: \$20 + Sash – **Sponsored by Vjay's Sewing Services**



SPECIAL NEEDS 12 YEARS AND UNDER

State Age on Entry Form

Prize: 1st - \$5 + Sash, 2nd - \$3, 3rd - \$2, Highly Commended Card

Class 27138 Crochet

Any Article

Class 27139 Knitting

Any Article

Class 27140 Embroidery Work

Any Article

Class 27141 Any Machine-Made Article

Class 27142 Any Craft Item

Class 27143 Any Other Painted Article

Class 27144 Any Article Not Specified

Class 27145 Pin Cushion

Any Medium

CHAMPION SPECIAL NEEDS 12 YEARS AND UNDER

Prize: Sash

SPECIAL NEEDS 13 YEARS TO UNDER 18 YEARS

State Age on Entry Form

Prize: 1st - \$5 + Sash, 2nd - \$3, 3rd - \$2, Highly Commended Card

Class 27146 Crochet

Any Article

Class 27147 Knitting

Any Article

Class 27148 Embroidery Work

Any Article

Class 27149 Any Machine-Made Article

Class 27150 Any Craft Item

Class 27151 Any Other Painted Article

Class 27152 Any Article Not Specified

Class 27153 Pin Cushion

Any Medium

CHAMPION SPECIAL NEEDS 13 YEARS TO UNDER 18 YEARS

Prize: Sash

NEEDLEWORK – CONTINUED**SPECIAL NEEDS - OPEN****State Age on Entry Form****Prize:** 1st - \$5 + Sash, 2nd - \$3, 3rd - \$2, Highly Commended Card

Class 27154 Crochet

Any Article

Class 27155 Knitting

Any Article

Class 27156 Embroidery Work

Any Article

Class 27157 Any Machine-Made Article

Class 27158 Any Craft Item

Class 27159 Any Other Painted Article

Class 27160 Any Article Not Specified

Class 27161 Pin Cushion

Any Medium**CHAMPION SPECIAL NEEDS - OPEN****Prize:** Sash**GRAND CHAMPION NEEDLEWORK ARTICLE OF SHOW****Prize:** Sash**GRAND CHAMPION OF HALL****Prize:** Sash

LAPIDARY

KEY INFORMATION

Entry Fee: FREE - *limit of 2 entries per person, per class.*

Prize: 1st - \$8 + Card, 2nd - \$4 + Card, 3rd -Card, Highly Commended Card.

Delivery of Exhibits:

1. All entries must be delivered by 10am 2nd June - Members of the Cairns Mineral & Lapidary Club must deliver their entries to the Club directly. Members of the Public must deliver their entries to the Cairns Show Office.
2. No late entries will be accepted.
3. All entries must be accompanied with the General Entry Form, or a copy of the Showday Online entries.
4. Entries may be posted to the Cairns Show Office by 3rd June. Please post to PO Box 811 Bungalow, QLD 4870.

Judging: 12pm Tuesday 16th July. Judge is an accredited Judge for QLD Lapidary & Allied Craft Clubs Association (QLACCA).

Collection of Entries: *To be confirmed.*

CONDITIONS OF ENTRY

1. The competition is classed as a level two competition. This competition shall be run in accordance with the AFLACA Competition and Judging Manual Issue No.8, April 2015.
2. All possible care will be taken with entries, but the committee will not be held responsible for any loss or damage during display, storage, or transport. Insurance is the responsibility of the competitor.
3. All entries are to be the applicant's own work. No entry must have won at the same level, group, and division.

NOVICE SECTION

Class 27162 N.16 Gem Tree

Class 27163 N.1A Standard Cabochon

Minimum Size 29mm on Longest Axis. Any material - craftsmanship.

Class 27164 N.8A Faceted Standard Round Brilliant with Continuous Girdle

Minimum Size 8mm - Quartz

Class 27165 N.18E Wire Wrapped Jewellery with Lapidary Item Cut and Set by Entrant

Class 27166 N.18D Hand Fabricated Jewellery with Commercial Lapidary Item/s

Set by Entrant - Any material.

Class 27167 N.20A Cast Jewellery Not Intended to Include Lapidary

OPEN SECTION

Class 27168 O.1B Fancy Cabochon

Any material - craftsmanship.

Class 27169 O.9A Faceted Standard Oblong Step cut with Cut Corners
Quartz.

Class 27170 O.18E Wire Wrapped Jewellery with Lapidary Item/s Cut and Set by Entrant

Any material.

Class 27171 O.18A Hand Fabricated Jewellery without Lapidary



STANDARD OBLONG STEP CUT WITH CUT CORNERS

Section O.9A Quartz Facets 53: Meets 44 (Crown – 24, Pavilion – 20)
 NOTE: Stone L/W ratio must generate an obvious 'keel'
 Angles for R.I. = 1.540
 45 + 8 girdles = 53 facets
 2-fold, mirror-image symmetry
 96 index
 L/W & T/W = refer to step G2 U/W = 0.554
 P/W = 0.656 C/W = 0.240
 Vol./W³ = refer to step G2

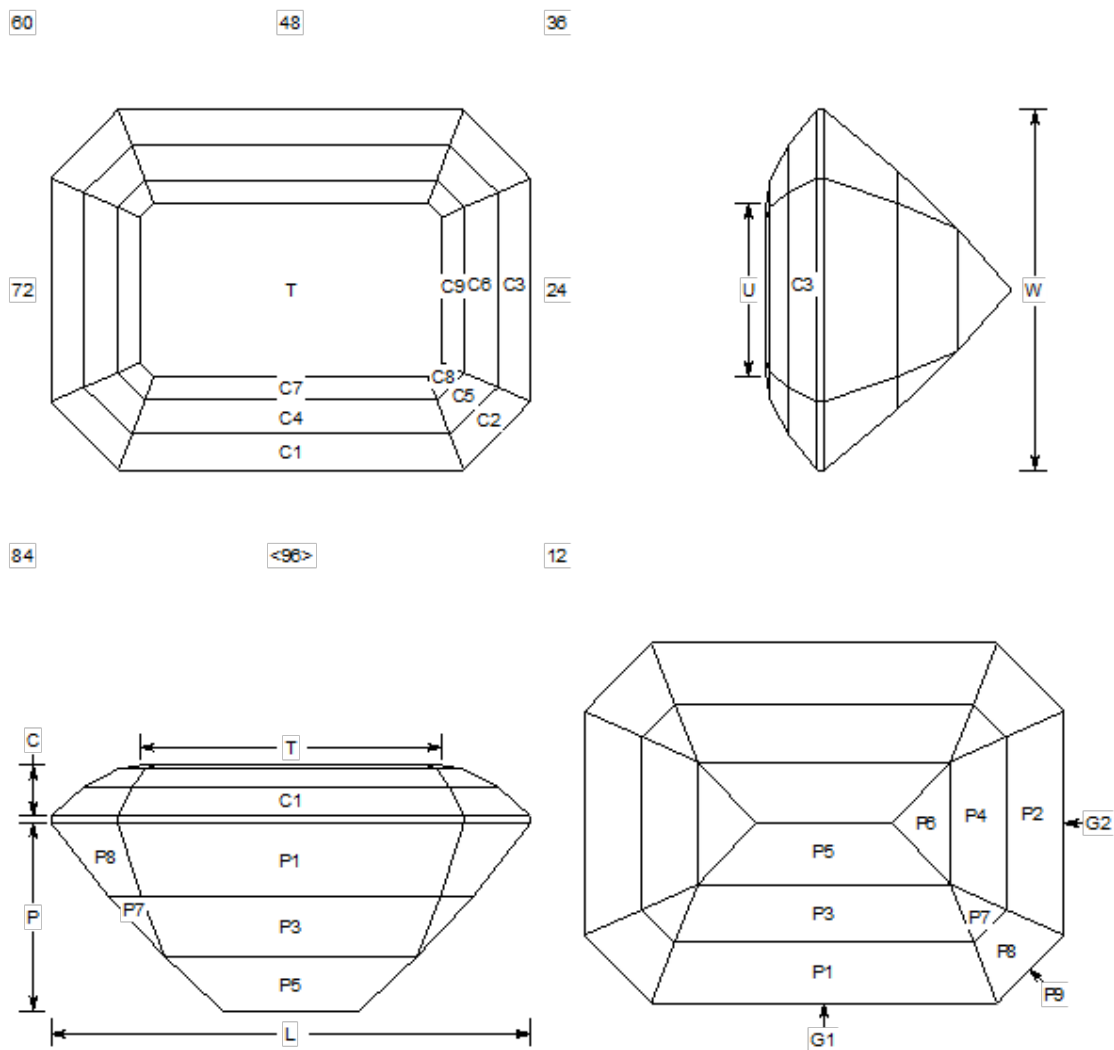

PAVILION				CROWN			
G1	90.00 ⁰	96-48	Set width	C1	55.00 ⁰	96-48	Set girdle thickness
G2	90.00 ⁰	24-72	Set length, see NOTE	C2	55.00 ⁰	12-36-60-84	Level girdle
P1	63.00 ⁰	96-48	Form girdle	C3	55.00 ⁰	24-72	Level girdle
P2	63.00 ⁰	24-72	Level girdle	C4	42.00 ⁰	96-48	Judge height by eye
P3	53.00 ⁰	96-48	Judge depth by eye	C5	42.00 ⁰	12-36-60-84	Meet C1-C2-C4
P4	53.00 ⁰	24-72	Meet P1-P2-P3	C6	42.00 ⁰	24-72	Meet C2-C3-C5
P5	43.00 ⁰	96-48	Judge depth by eye, form keel	C7	26.00 ⁰	96-48	Judge height by eye
P6	43.00 ⁰	24-72	Meet P3-P4-P5	C8	26.00 ⁰	12-36-60-84	Meet C4-C5-C7
P7	53.00 ⁰	12-36-60-84	Meet P3-P4-P5-P6	C9	26.00 ⁰	24-72	Meet C5-C6-C8
P8	63.00 ⁰	12-36-60-84	Meet P1-P3-P7	T	0.00 ⁰	Table	Judge height by eye
P9	90.00 ⁰	12-36-60-84	Level girdle				

STANDARD ROUND BRILLIANT WITH CONTINUOUS GIRDLE

Section N.8A Quartz Facets 58: Meets 41 (Crown – 24, Pavilion – 17)
 Angles for R.I. = 1.540
 57 + 1 rolled girdle = 58 facets
 8-fold, mirror-image symmetry
 96 index
 L/W = 1.000 T/W = 0.556 U/W = 0.556
 P/W = 0.450 C/W = 0.139
 Vol./W³ = 0.198

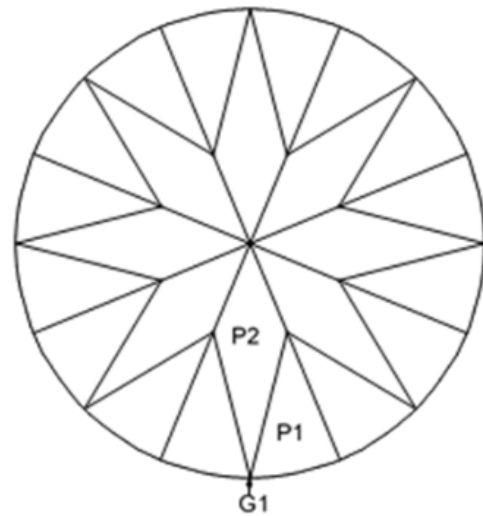
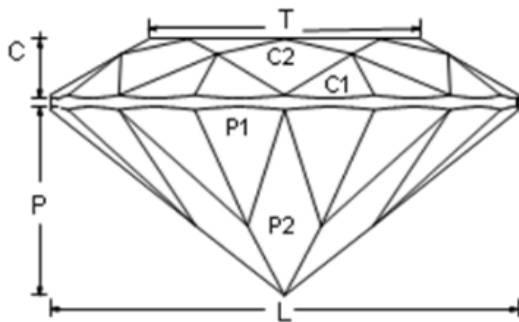
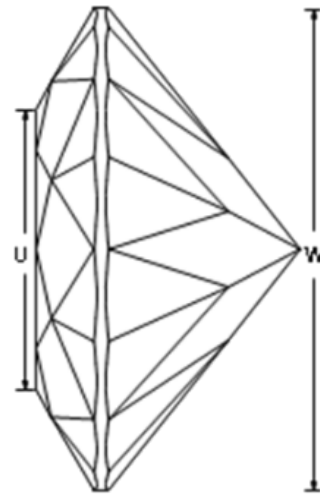
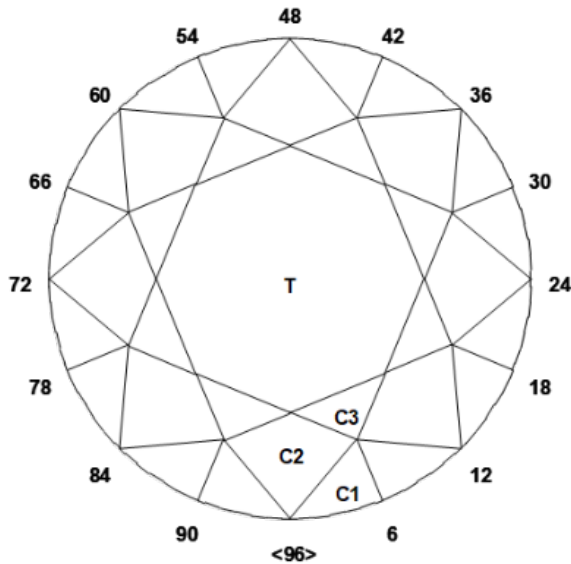

PAVILION		CROWN			
03-09-15-21-27-33-39-45-51-57-63-69-75-81-87-93	Create TCP	C1	42.00 ⁰	03-09-15-21-27-33-39-45-51-57-63-69-75-81-87-93	Set girdle thickness
Girdle	Cut to size, rolled girdle	C2	35.00 ⁰	96-12-24-36-48-60-72-84	Meet C1, G
96-12-24-36-48-60-72-84	Meet P1, G, form PCP	C3	20.00 ⁰	06-18-30-42-54-66-78-90	Meet C1, C2
		T	0.00 ⁰	Table	Meet C3, C2, C3

ARTS & CRAFTS PAVILION LEGO CHALLENGE

LEGO BUILDING - MAKE YOUR OWN DESIGN

PRIZES TO BE WON!

CATEGORIES

CLASS 27172 JUNIOR - UNDER 12 YEARS

CLASS 27173 JUNIOR - 13 TO UNDER 18 YEARS

CLASS 27174 SENIOR - 18 YEARS & OVER

CLASS 27175 SPECIAL NEEDS



SPONSORS

THANK YOU!

The Cairns Show Association wishes to record its sincere appreciation to the following Cairns Show Sponsors who have contributed to this event.

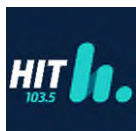

SPONSORS



Queensland Ag Shows

